

LT Panel System: Pedestal Base

Part Number	Description
1	Side Panel
2	Front Panel
3	Side Panel
4	Back Panel with Door

- Steps
- 1) Connect podium panels together in numerical order.
 - 2) Velcro internal shelf supports to inside of assembled base.
 - 3) Place internal shelf atop supports.
 - 4) Place counter top atop assembled base.
 - 5) Attach upper Plexi shelf to top of counter using stand-offs.

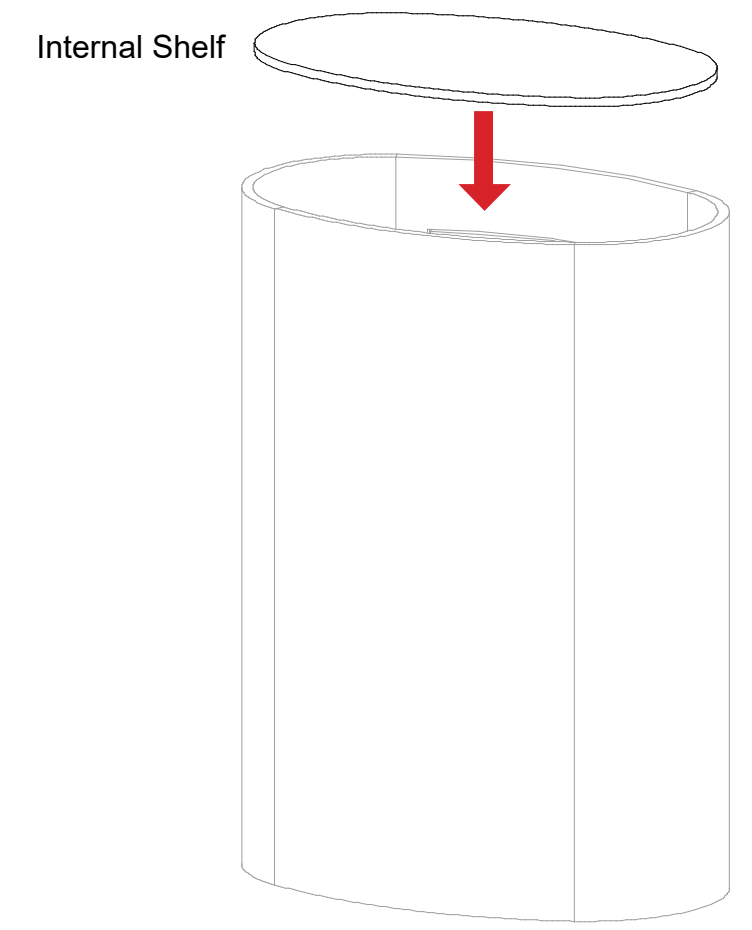
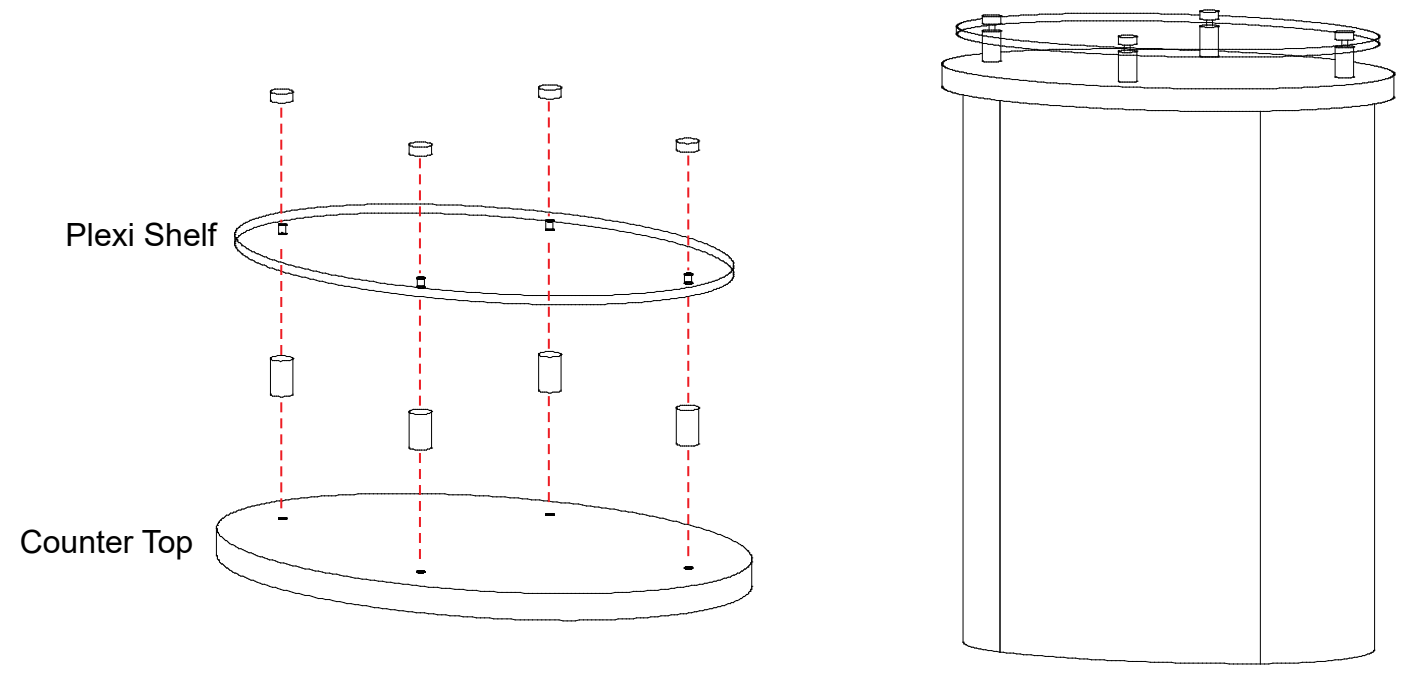
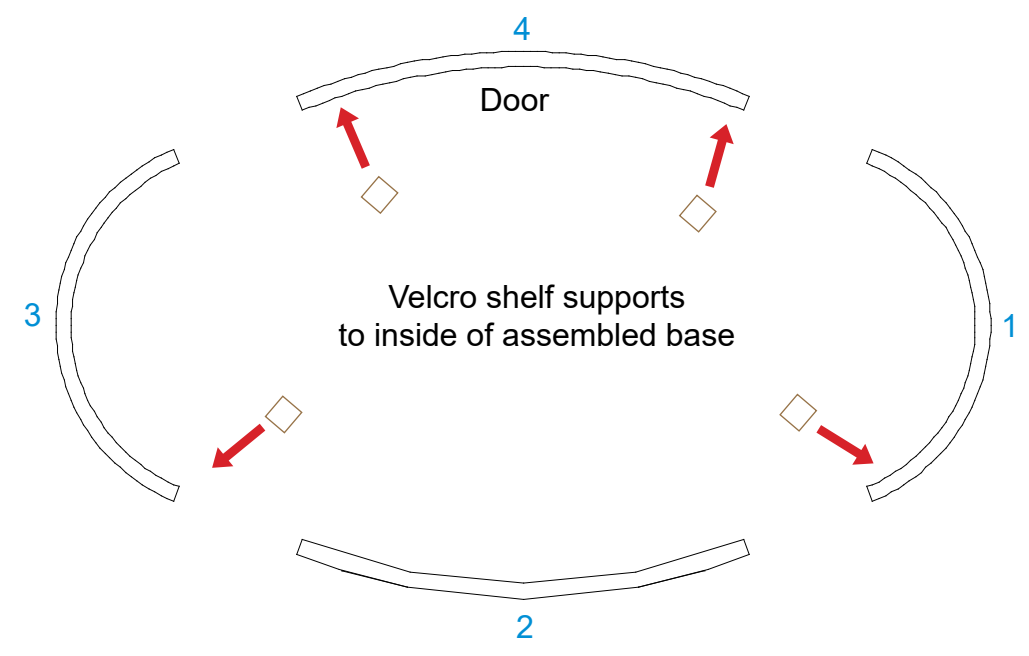

SETUP INSTRUCTIONS

LT Panel Assembly

- 1) With a vertical offset, place LT-Panels side-by-side; slide vertically offset panel down to lock panels together and in place.
- 2) Corner Connectors (90°, T-Connector, Straight Connector) connect just as panels connect together. Repeat Step 1 for installing corner connectors to panels.

LT Panel Disassembly

- 1) To disassemble push panel with upper locks horizontally to disengage top lock clip.
- 2) Slide panels or connectors vertically in opposing directions to release latches and disconnect parts.

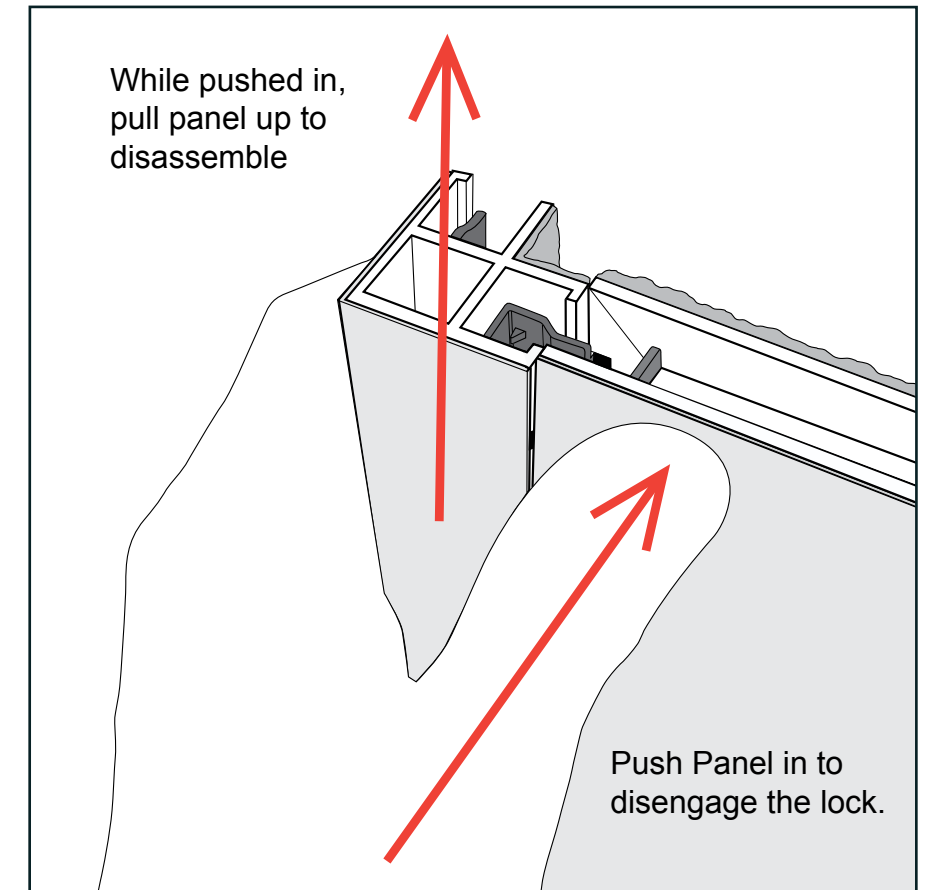
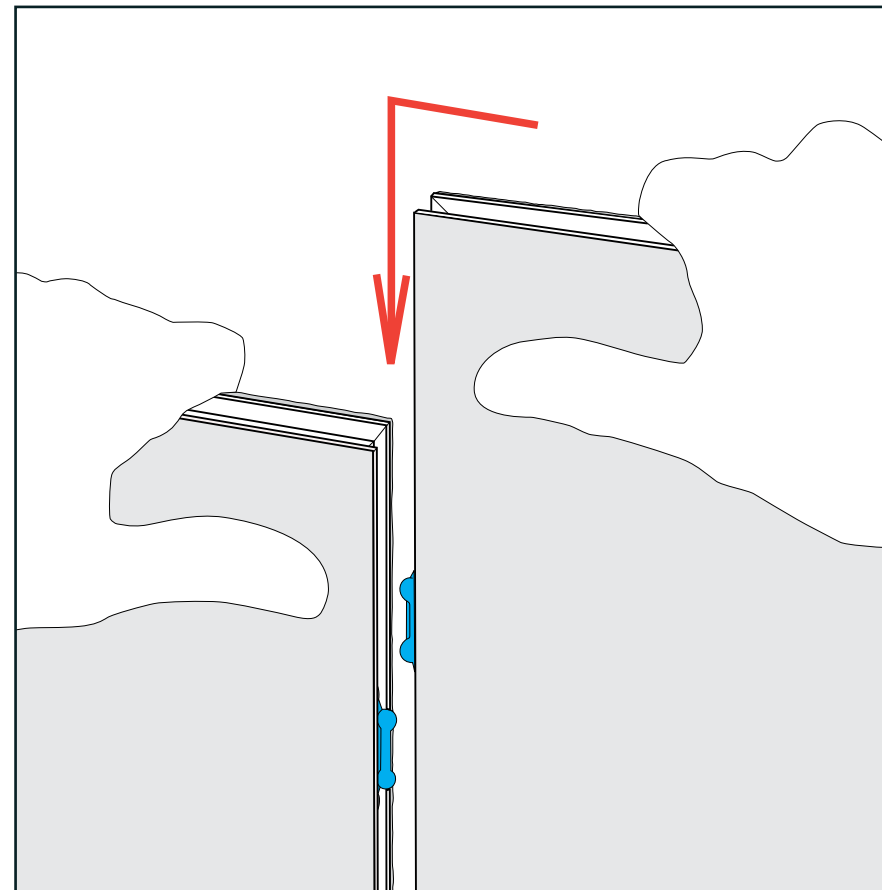

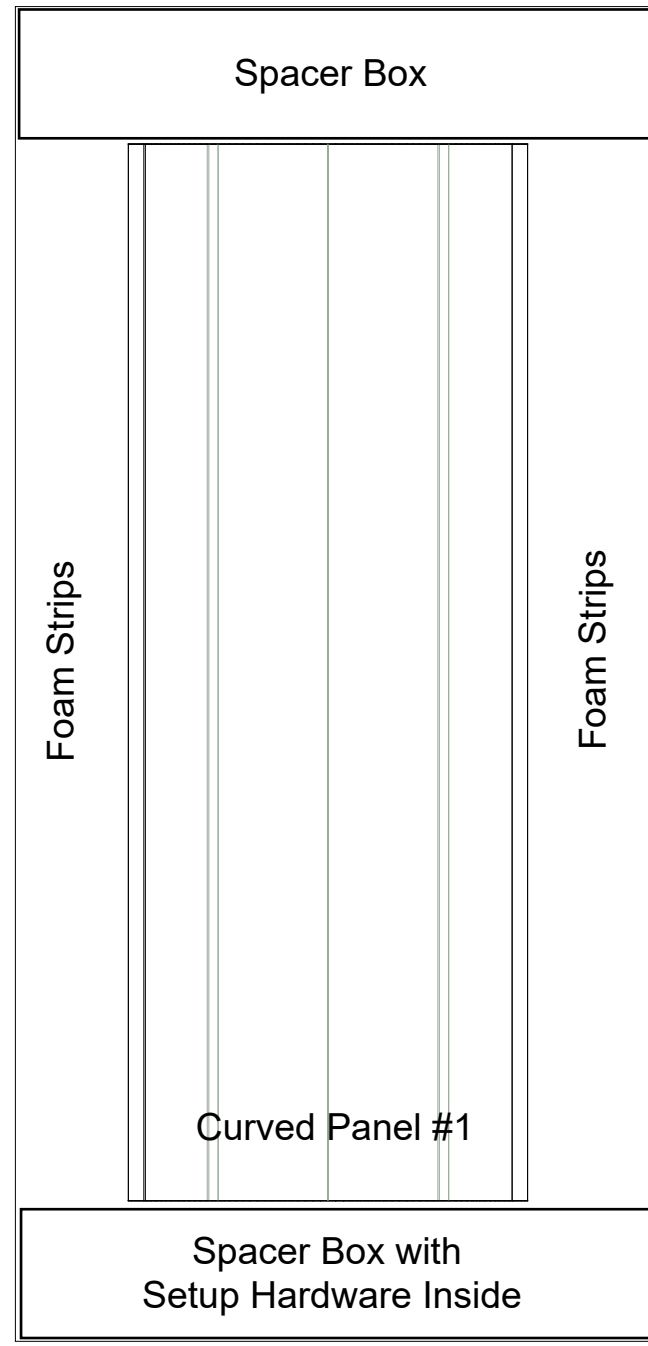

Level 1

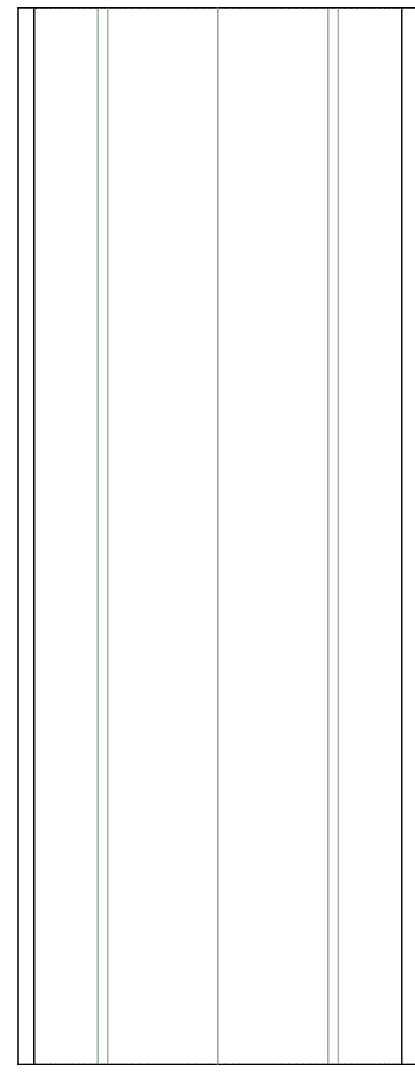

Level 2



Level 1

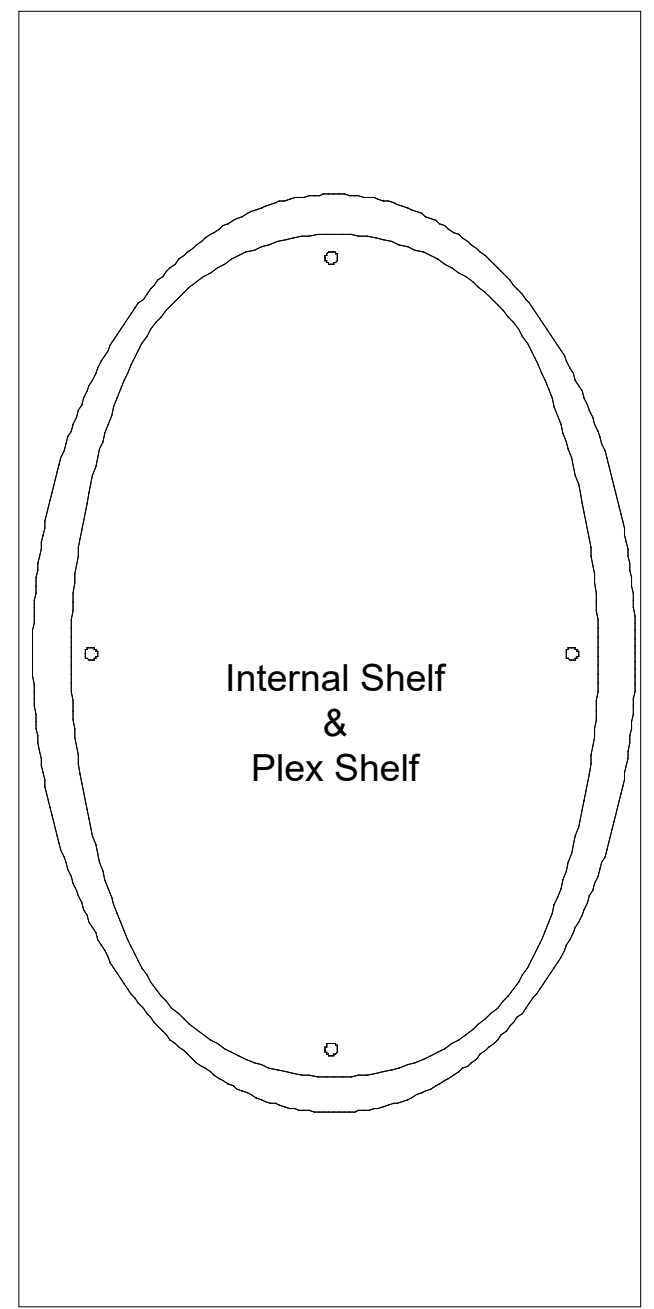

Level 2

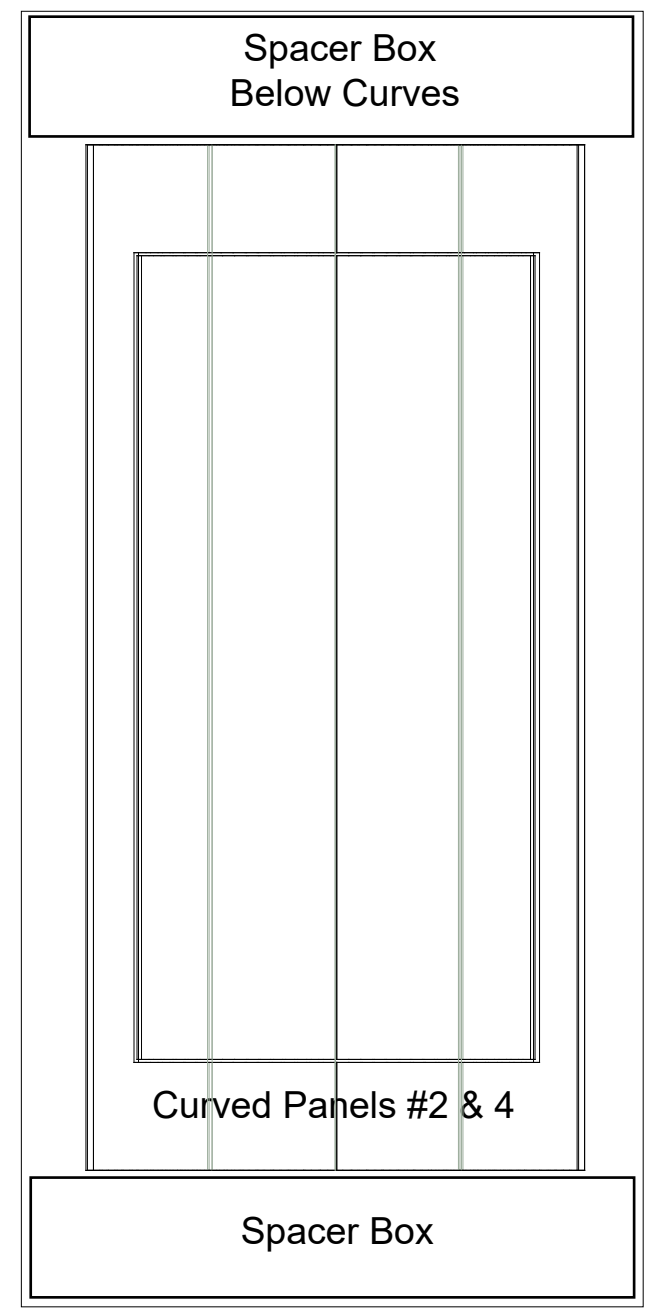

Level 3

2 Piece Counter Top

Internal Shelf
&
Plex Shelf

Spacer Box
Below Curves

Curved Panels #2 & 4

Spacer Box